



Canadian Healthcare
Engineering Society

Société canadienne d'ingénierie
des services de santé

2013 Webinar Series

**Plan to join us in Niagara Falls
for our National Conference**

**September 22-24, 2013
Scotiabank Convention Centre
Niagara Falls ON**

2013 Webinar Series

Conference Highlights

Theme: “Powering into the Future”

2 days of Education

Keynote speaker: Jay Ingram

Huge trade show and exhibit

Check it out at www.ches.org

CHES SCISS

Canadian Healthcare
Engineering Society

Επιχειρησιακή Σοσική

Société canadienne d'ingénierie
des services de santé

Σοσική Σερβιςων Υγείας

2013 Webinar Series



CHES SCISS

NATIONAL CONFERENCE | 2013 | CONGRÈS NATIONAL
Niagara Convention Centre | Niagara Falls Ontario
SEPTEMBER 22-24 SEPTEMBRE
www.ches.org

2013 Webinar Series

**Watch our website for information
on the 2014 webinar series**

Coming soon to

www.ches.org



Canadian Healthcare
Engineering Society

Société canadienne d'ingénierie
des services de santé

Επιχειρησιακή Σοσιετα

Οες Σελιαιες δε Σαυτε

2013 Webinar Series

Green HVAC Done Right

Our webinar will begin promptly at 12:00pm
Eastern Time



Canadian Healthcare
Engineering Society

Société canadienne d'ingénierie
des services de santé

ΕΠΙΧΕΙΡΗΣΙΟ ΣΟΣΙΕΤΑ

ΠΕΣ ΣΕΛΙΣΕΣ ΔΕ ΣΑΥΓΕ

2013 Webinar Series

Green HVAC Done Right

Please connect to the audio portion by dialing (866) 740-1260 in U.S. & Canada

Provide the access code: 7356888#

2013 Webinar Series

Green HVAC Done Right

Eugene “Smitty” Smithart



Introduction/Topics

- 1. Best Existing Building Upgrades**
- 2. Desiccant Dehumidification Strategies**
- 3. Photo-Catalytic Oxidation Technology**

Top Existing Facility Energy Upgrades



2nd

Towers fans should use VFDs!

1st



Pump Pressure Optimization



3rd



Use Ice to Add Tonnage - Easily



4th



Single Zone VAV



5th

Constant-Volume System

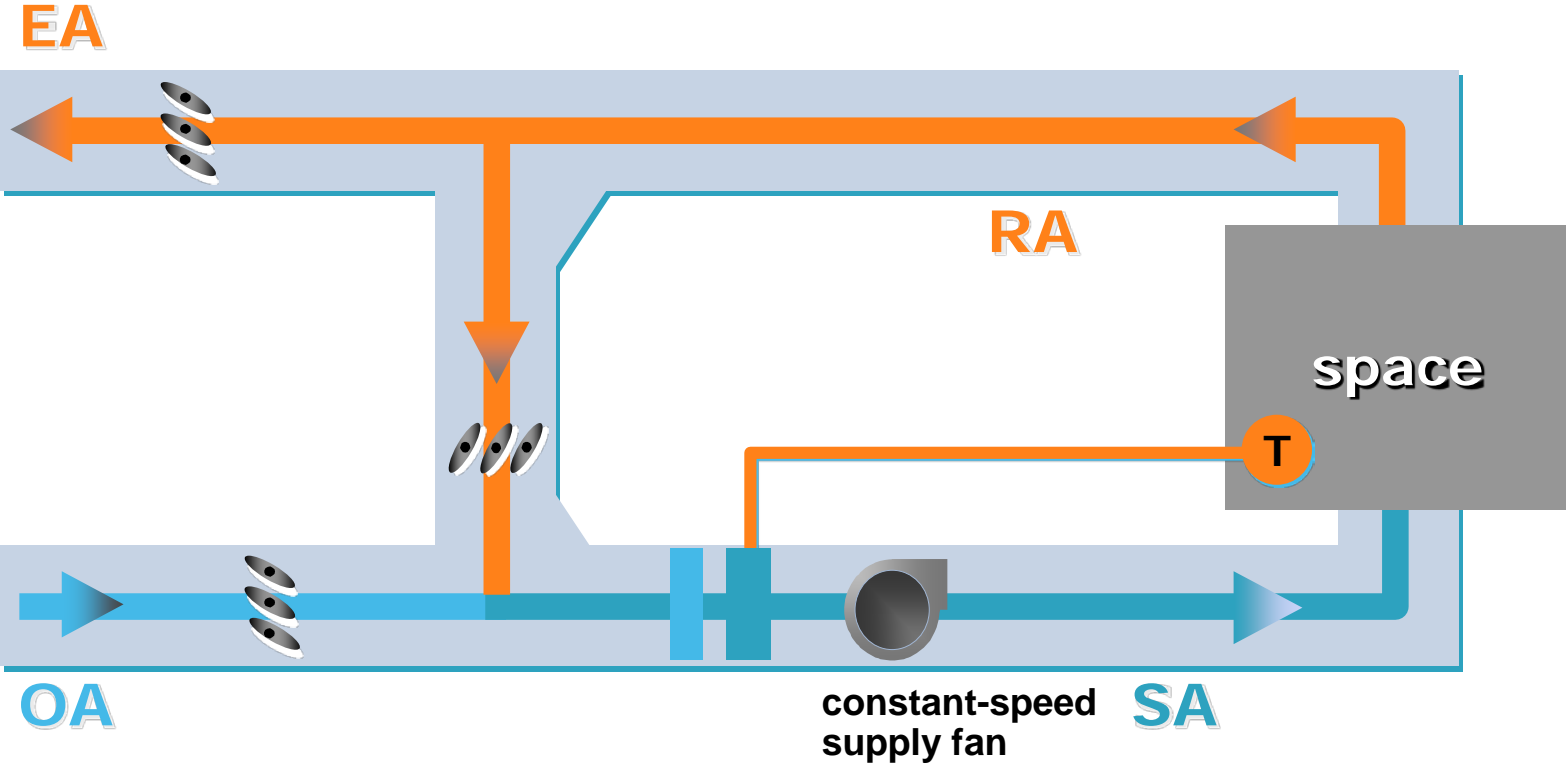

Single-Zone VAV System

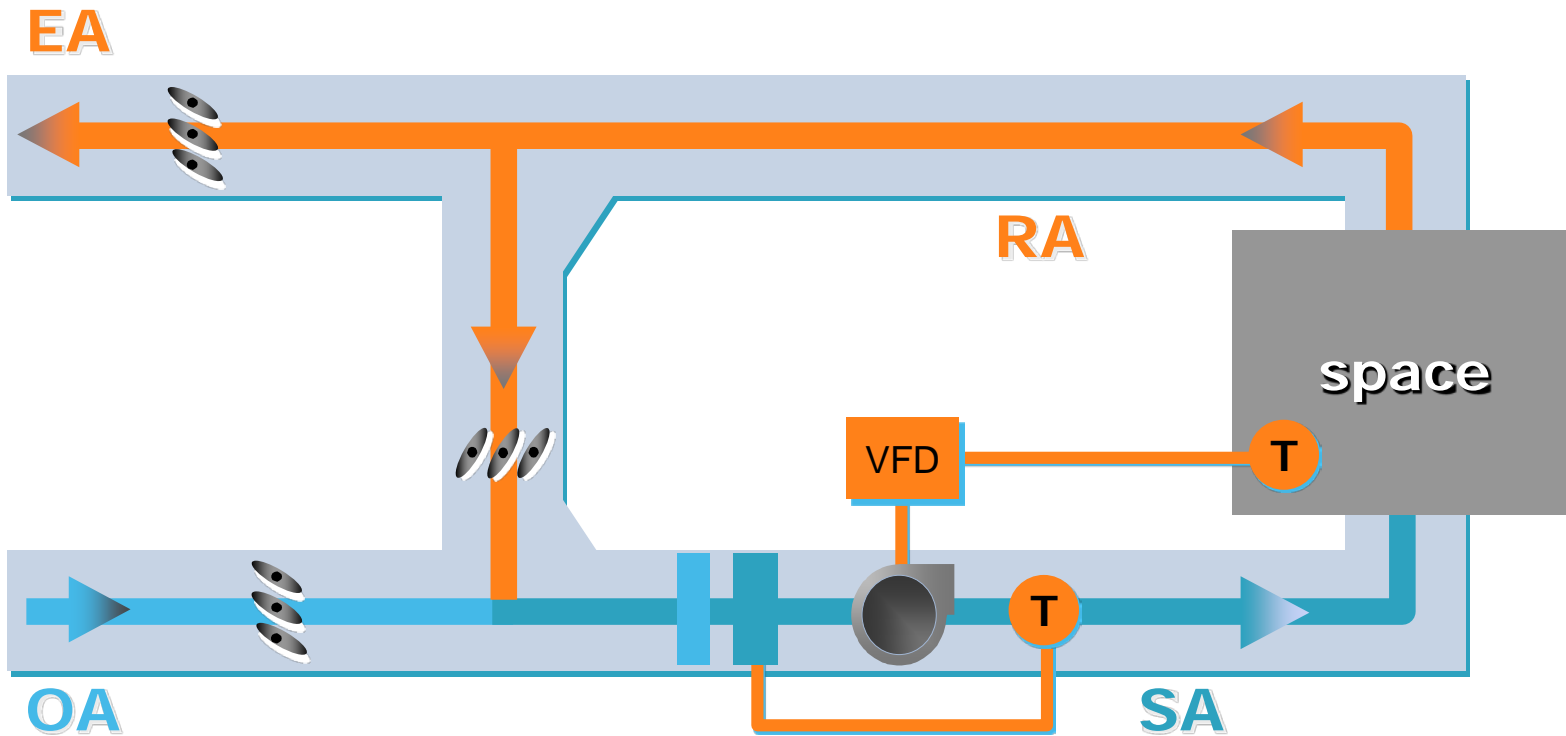

Single-Zone VAV System

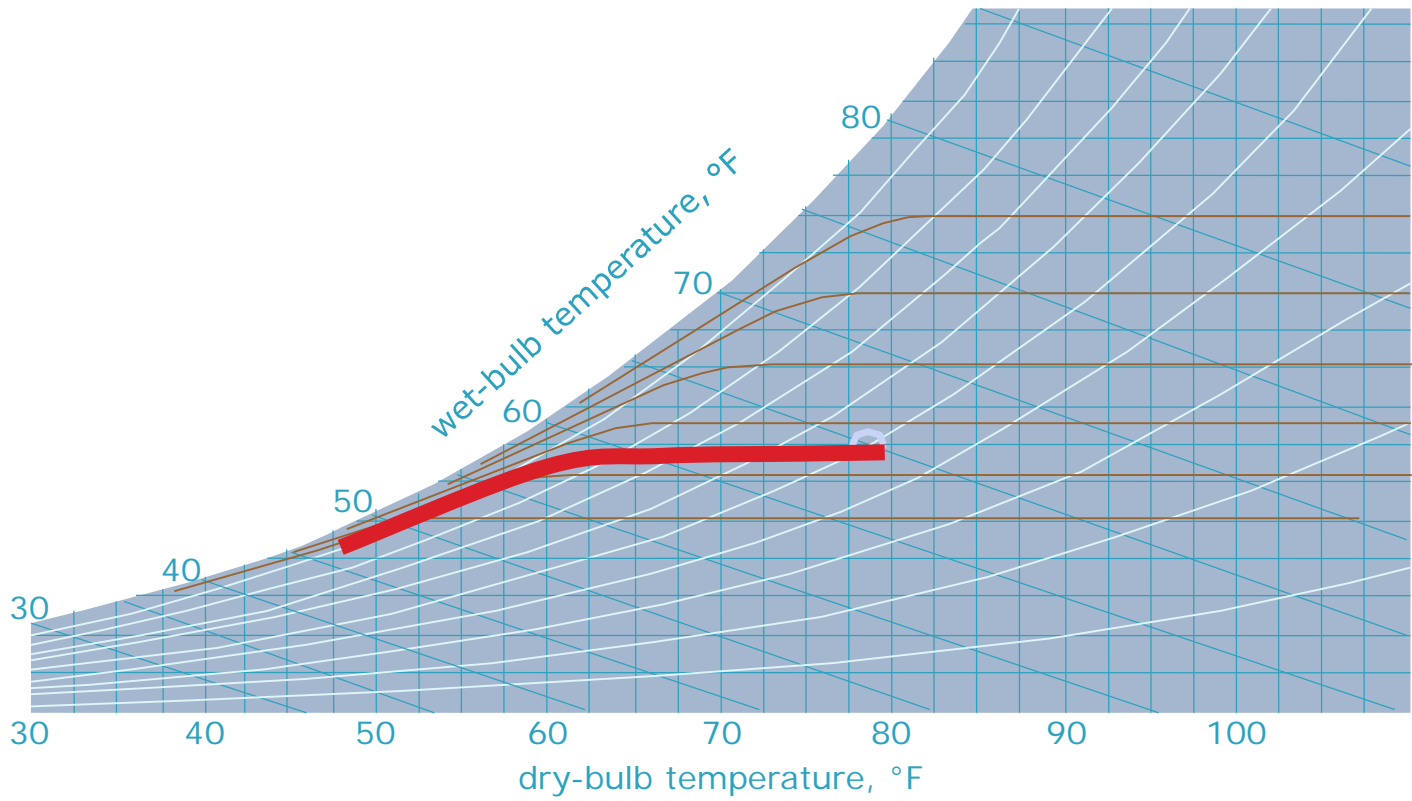

Single-Zone VAV System

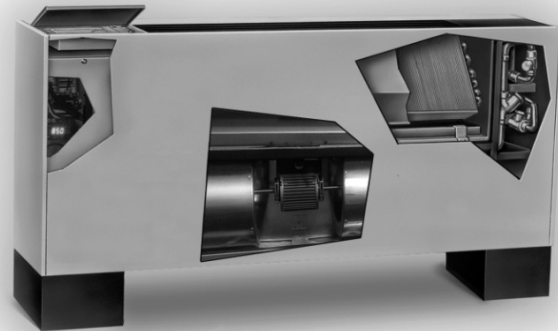

RIRO – 6th

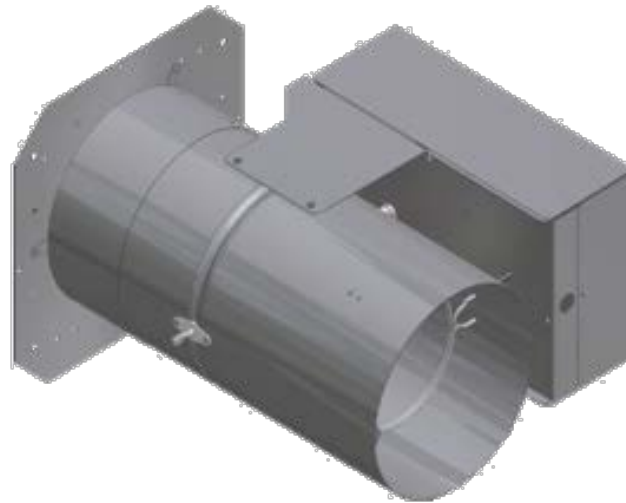
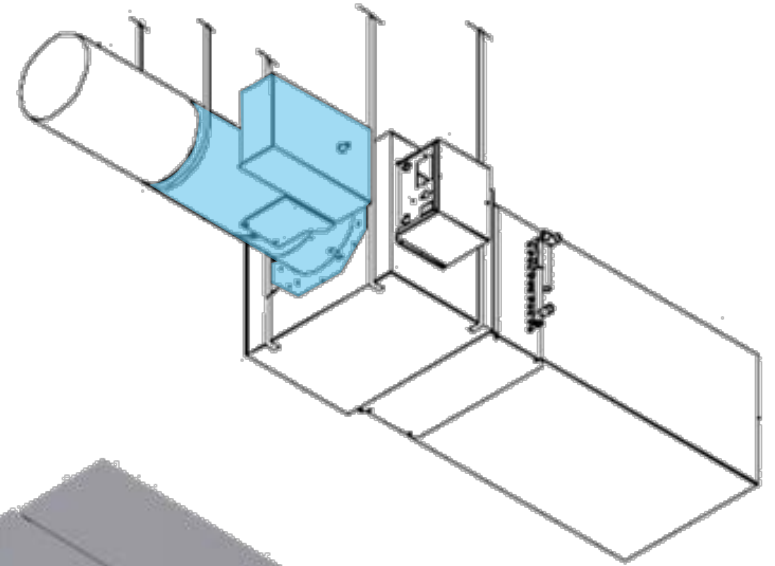
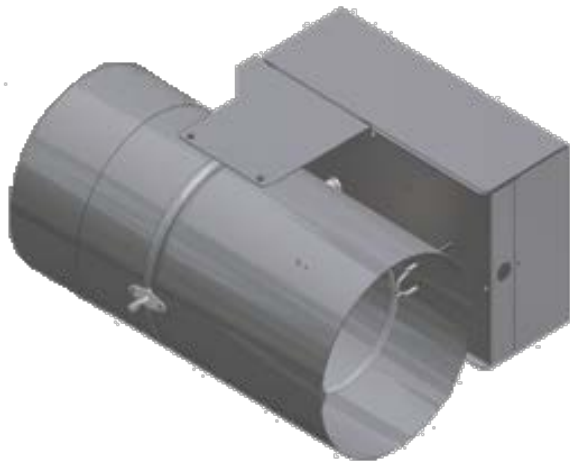

Desiccant Dehumidification

Desiccant Dehumidification

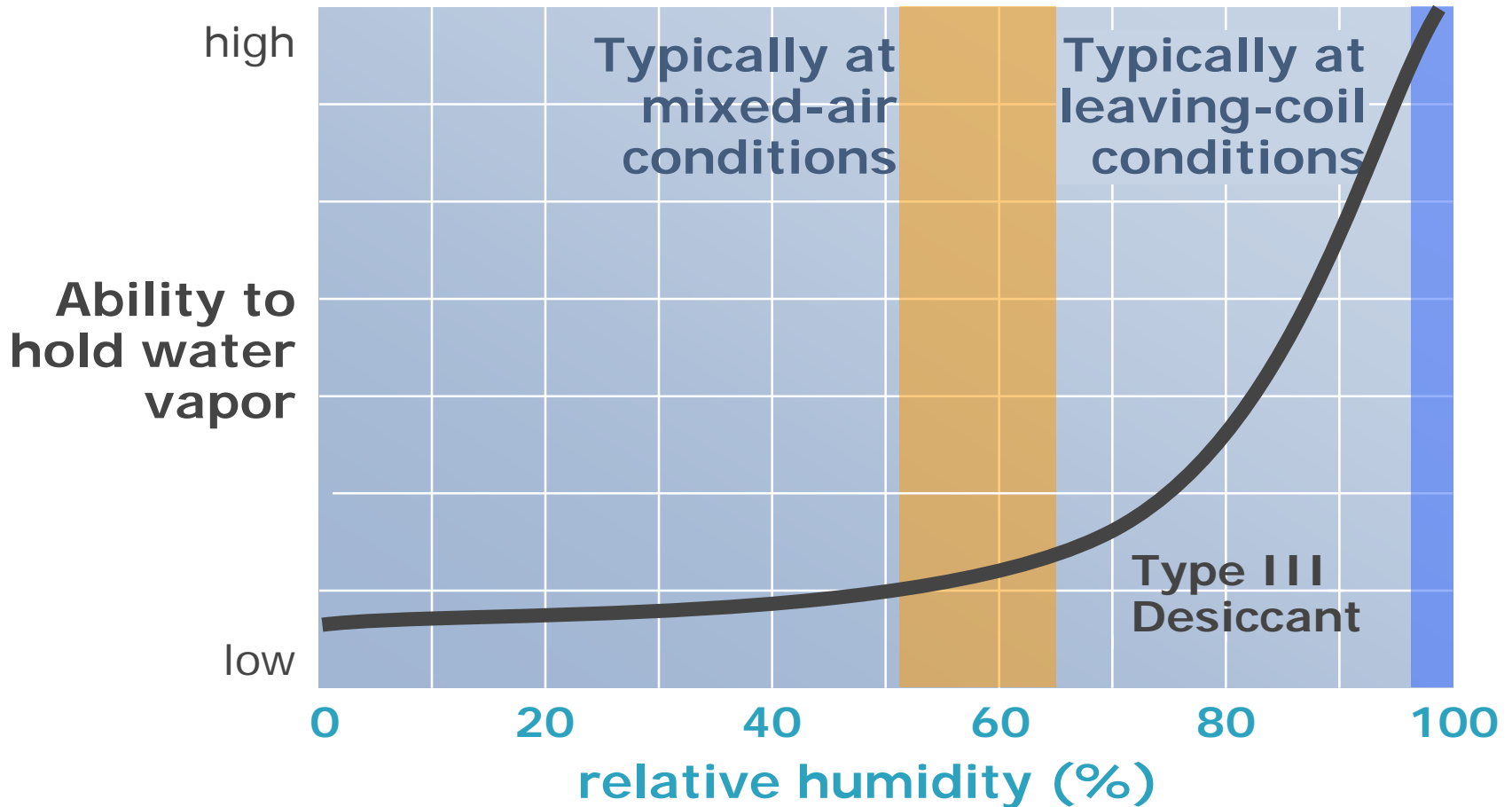

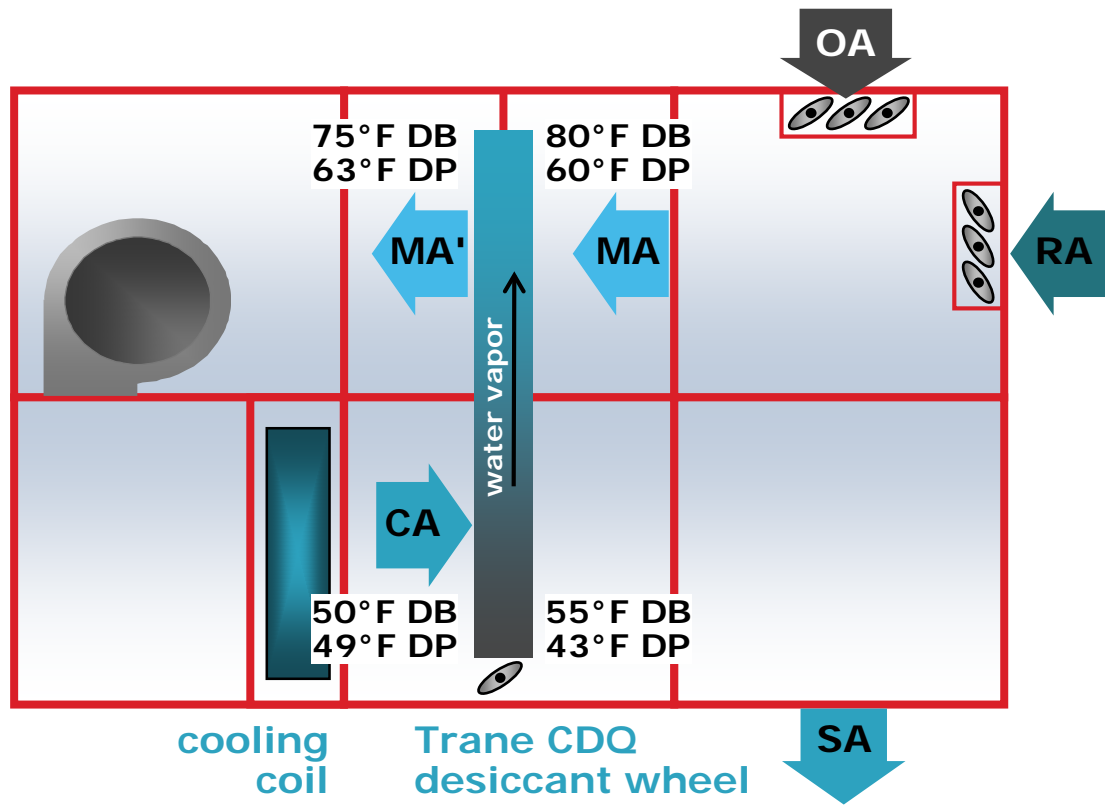

OA 100°F DB
74°F WB

RA 62°F DB
50% RH

MA 80°F DB
53.5°F DP

MA' 76°F DB
58.5°F DP

CA 51°F DB
49°F DP

SA 55°F DB
42°F DP

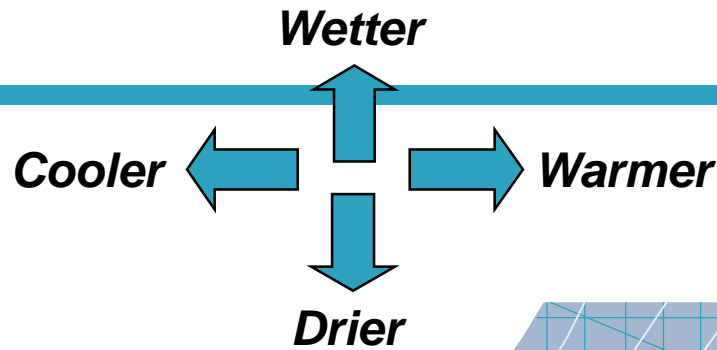

CDQ requires:
• less cooling tons
• less reheat

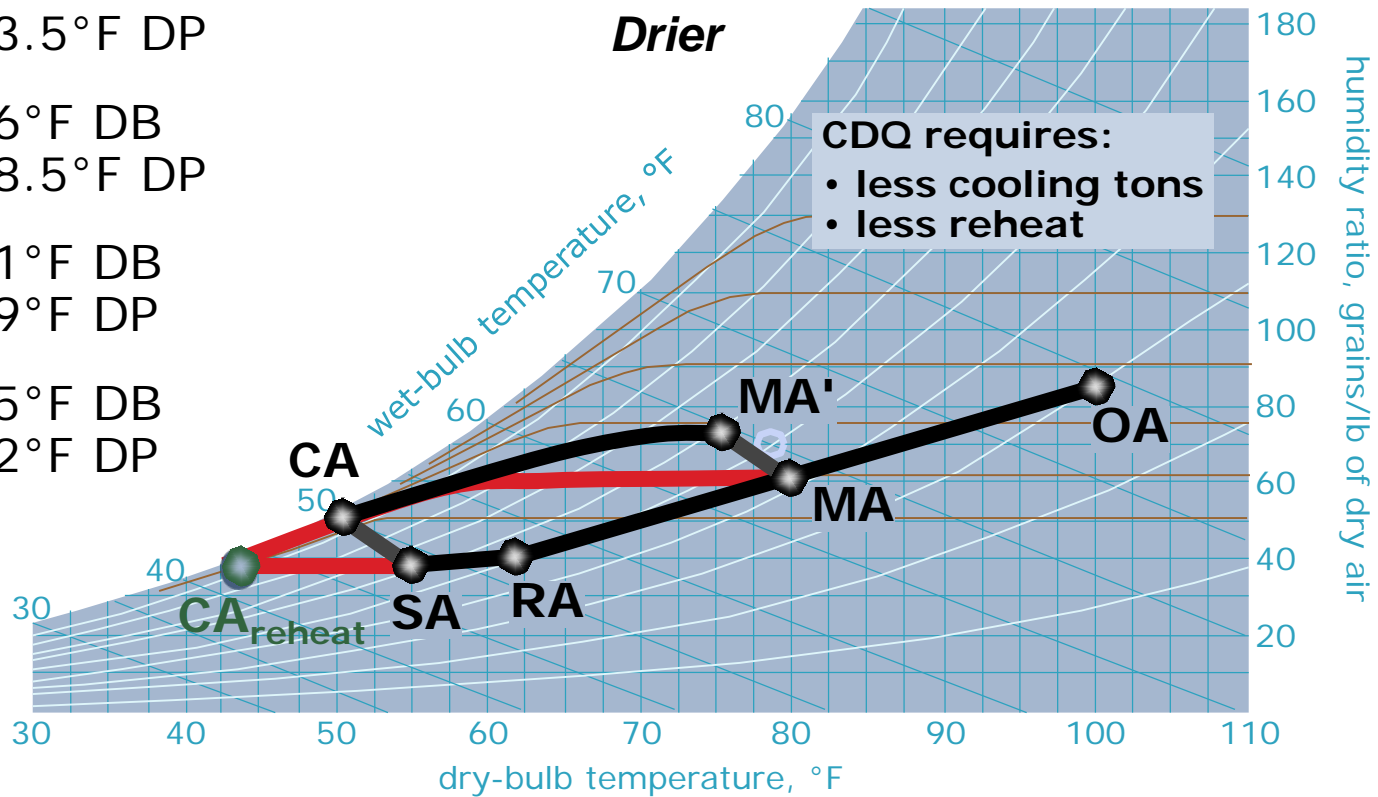



Franklin Hospital, Portland, Me.

Results:

- Hospital acquired infections dropped by 50%.
- Surgical suite changeover time cut from 18 minutes down to 12 minutes.
- Orthopedic Surgical team no longer have to wear ice vests.
- Surgical Suite conditions have become a recruiting tool.

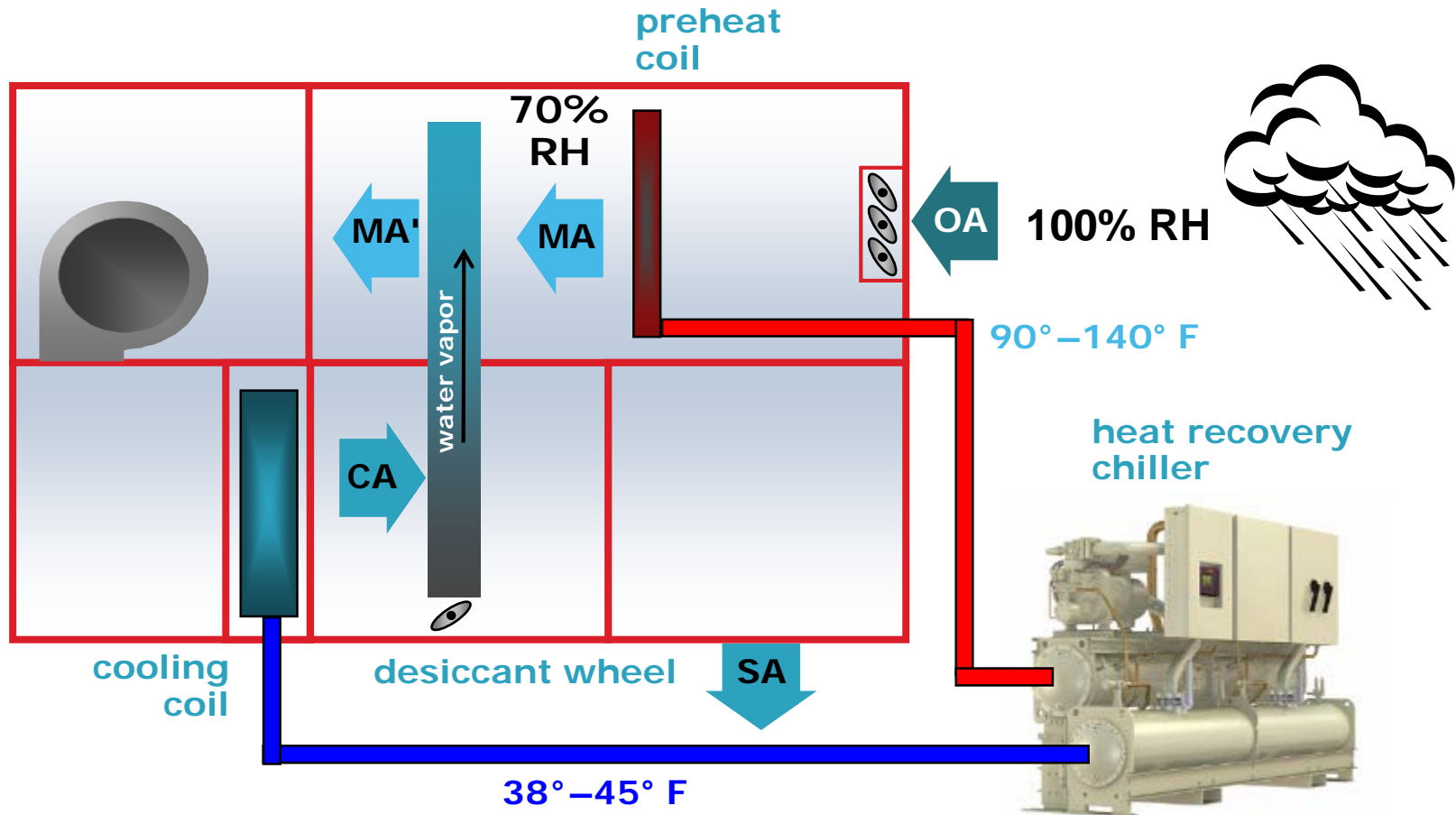

for floor-by-floor applications

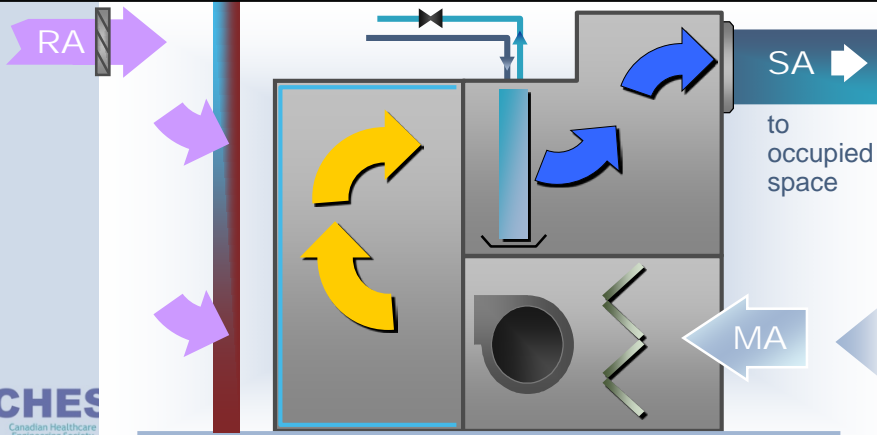
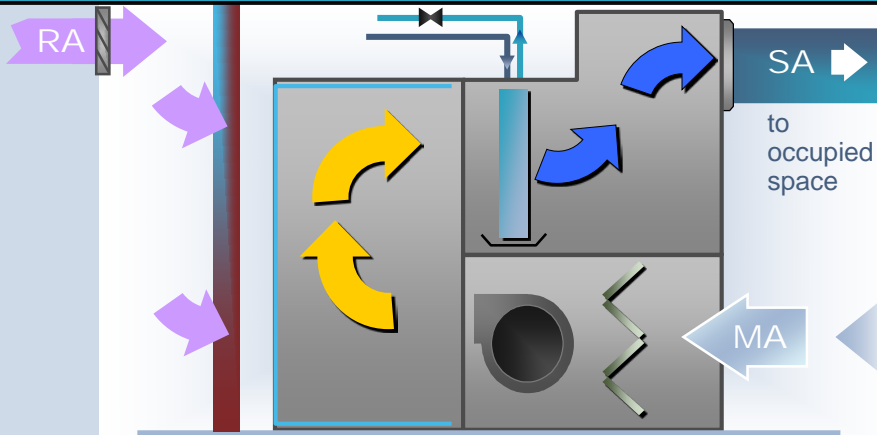
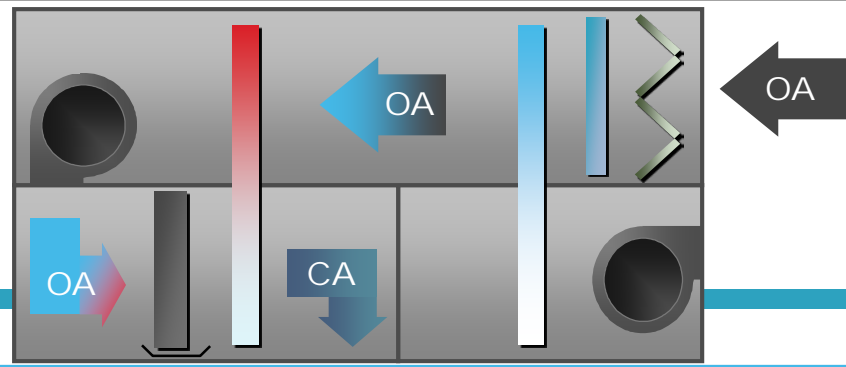

for floor-by-floor applications

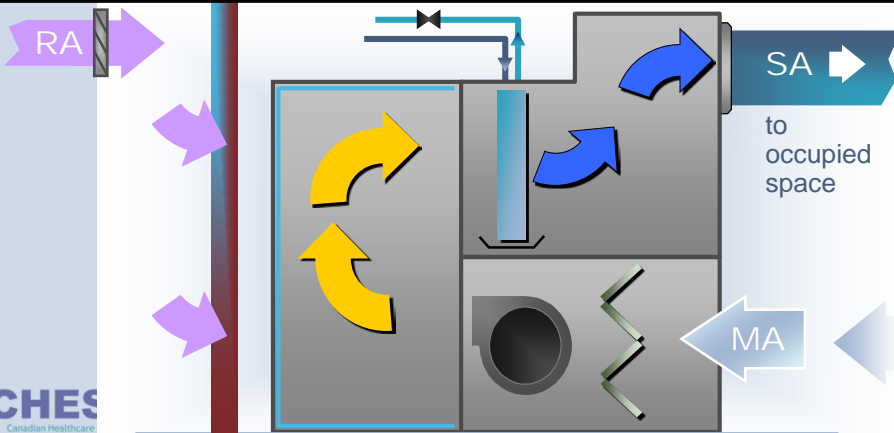
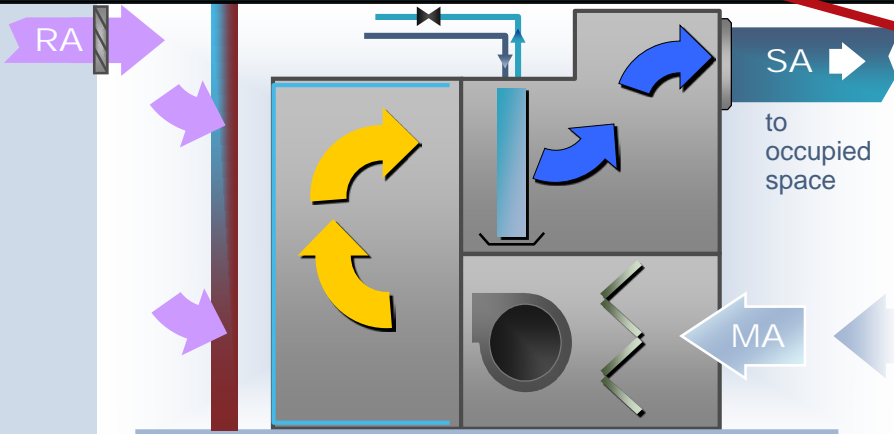
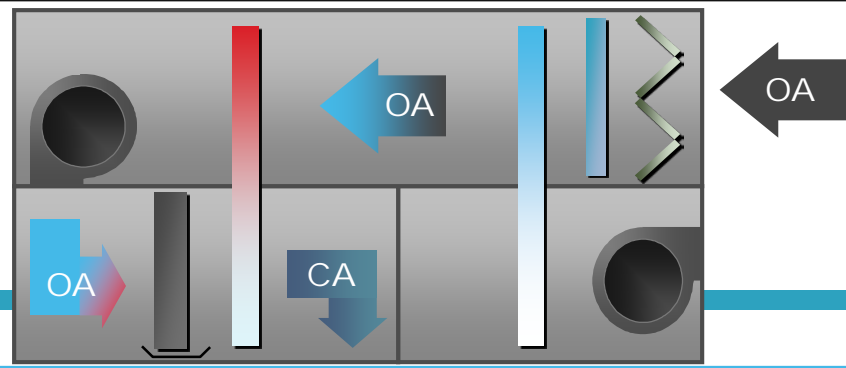

Dedicated OA System Choices

Dew Point of Conditioned Outdoor Air (CA)

35° F 40° F 45° F 50° F 55° F 60° F

Dew point required

- ◆ 60% space RH
- ◆ 50% space RH

Dew point capability

packaged
DX rooftop

mechanical
dehumidifier

chiller + AHU

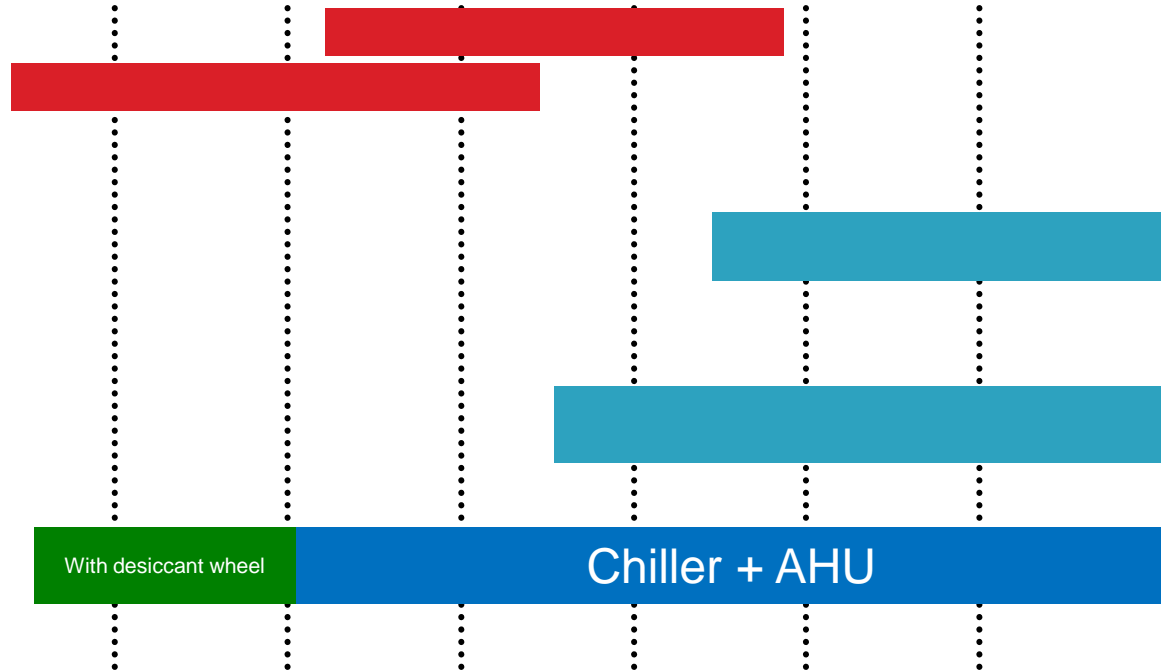
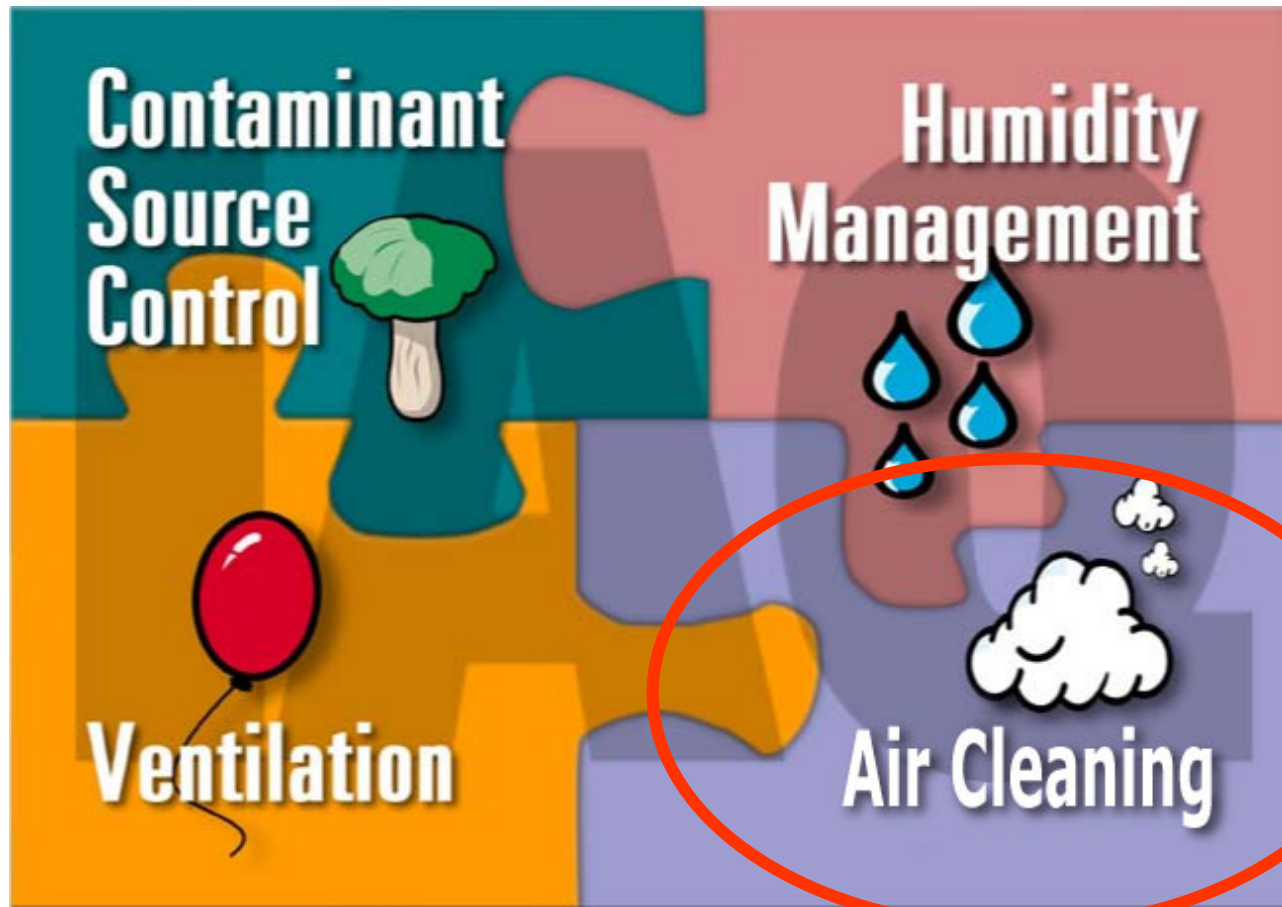

Photo-Catalytic Oxidation





Air Cleaning

- ✓ Keep buildings clean
- ✓ Help HVAC system performance
- ✓ Minimize adverse health effects
- ✓ Code or process requirements
- ✓ Risk Reduction

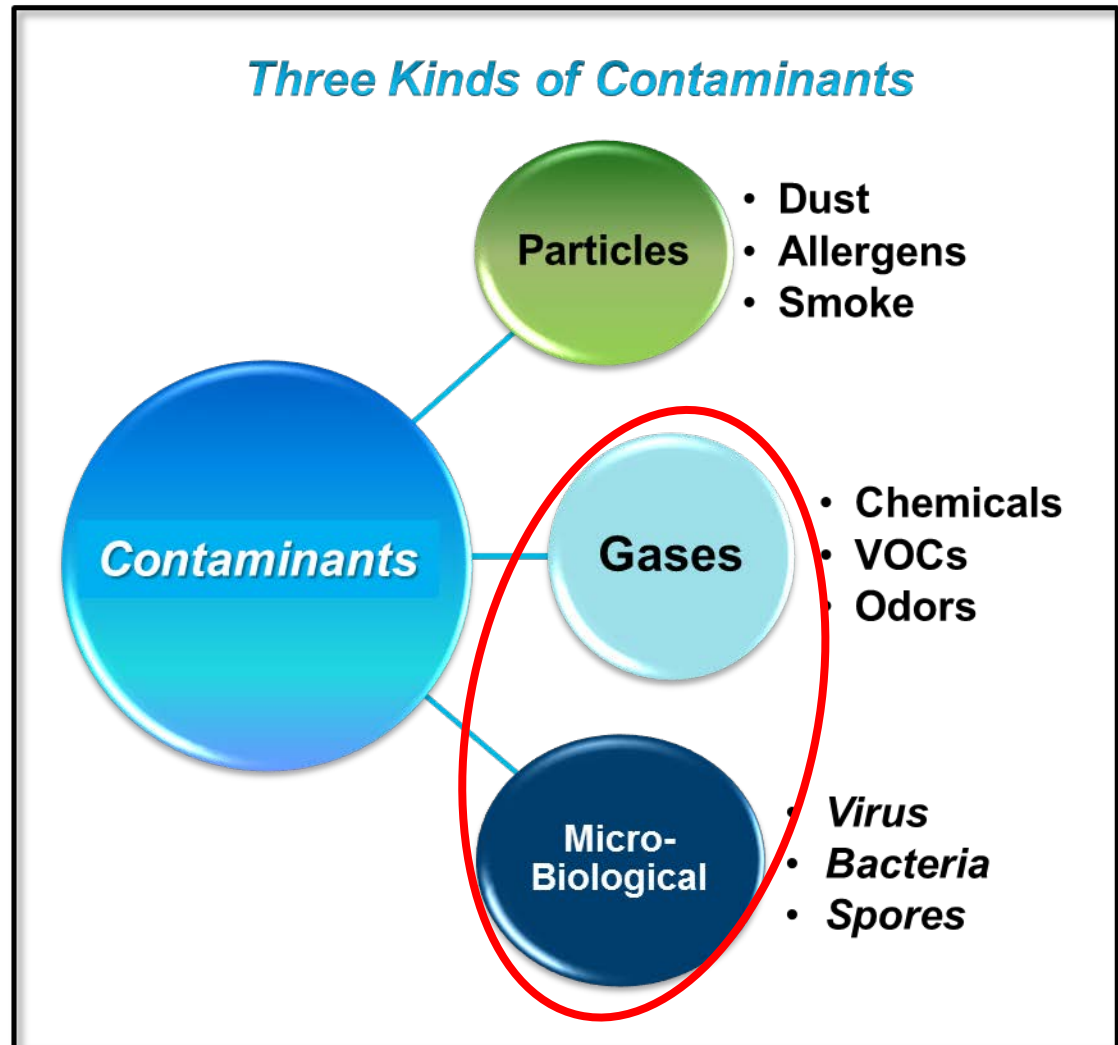

Ever hear comments like these?

- **Those locker rooms smell awful.**
- **Can we get rid of that diesel/gas smell?**
- **The air in here seems to clog my sinuses and give me a headache.**
- **Can we do a better job in reducing airborne infection rates?**

Three Stage Approach:

- First stage - MERV 13 particulate filter
- Second & Third stages –UV & PCO

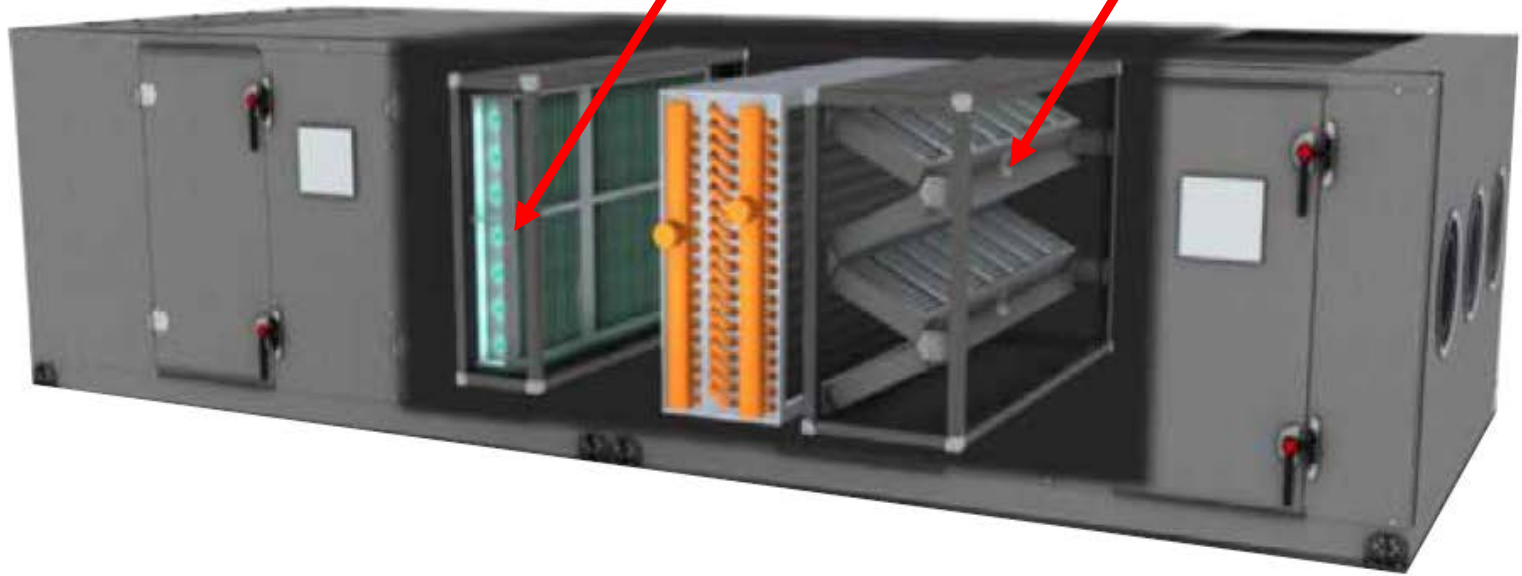
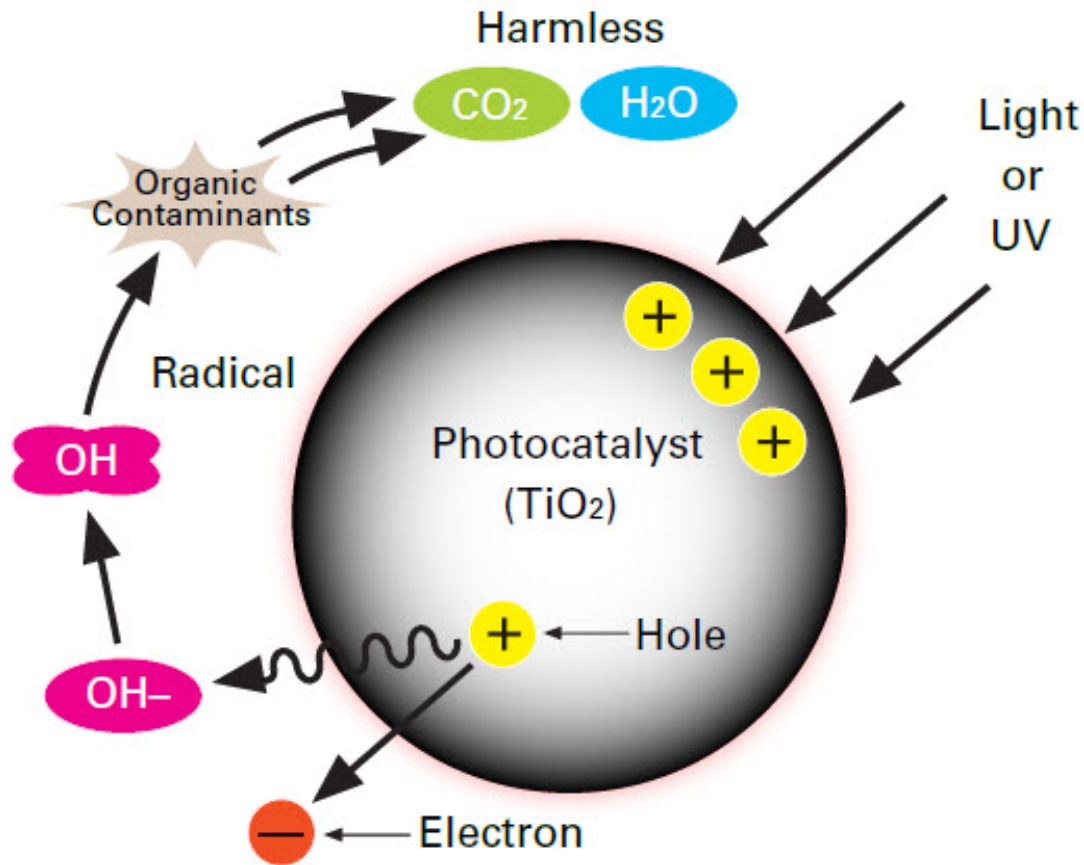

Photo-Catalytic Oxidation





From: San Francisco Airport Facilities & Engineering
Sent: Friday, August 06, 2010 2:57 PM

Subject: a complaint

I have never been so upset in my life about air quality. Where did my jet fuel fumes go, where is the funk from the bathroom swirling through the center. I smell NOTHING -- NOTHING I say.

From: Head of Facilities SFO
Sent: Friday, August 06, 2010 6:12 PM

Subject: RE: a complaint

From the complaint ...the folk working there are not comfortable with the clean, pure air. They obviously prefer the smell of JP-4 jet fumes.

Seriously, ...the newly installed system is a success. Congrats to all who made this possible. . .

**Dr. Robert Scheir, PhD, Burbank
California – Article; HPAC, Feb 2013**

- **Hospital-acquired infections (HAIs) are a leading cause of death in the United States, killing more people than AIDS, breast cancer, and automobile accidents combined.**
- **Last year HAIs contributed to more than 99,000 deaths—one death every 6 min—and costs of up to \$57,000 per patient, with an increase in length of hospital stay of about 10 to 15 days.**

Summary

- 1. Best Existing Building Upgrades**
- 2. Desiccant Dehumidification Strategies**
- 3. Photo-Catalytic Oxidation Technology**



Canadian Healthcare
Engineering Society

Ευρωπαϊκή Σχολή

Société canadienne d'ingénierie
des services de santé

Ευρωπαϊκή Σχολή

2013 Webinar Series

Eugene “Smitty” Smithart

Director, Systems and Solutions

Trane Commercial Systems

Contact info:

Cell Phone: 608-498-1132

Email Address: smitty@trane.com